

2

Data Sheets

Data Sheets

This chapter presents the electrical parameters for the SIDACTor devices, which are Teccor's line of solid state over voltage protection devices.

Complete specifications for the following product families are presented on the following pages:

- DO-214AA SIDACTor device 2-3
- TO-92 SIDACTor device 2-6
- TO-220 Type 61 SIDACTor device 2-8
- Two Chip TO-220 SIDACTor device 2-10
- Balanced Three Chip TO-220 SIDACTor device 2-12
- Subscriber Line Interface Circuit (SLIC)
Protection 2-14
- Subscriber Line Interface Circuit (SLIC)
Protection Battrex 2-16
- CATV Series SIDACTor device 2-18

DO-214AA SIDACtor device

The DO-214AA SIDACtor solid state protection device is designed for telecommunication protection applications for modems, line cards, fax machines, etc.

The SIDACtor device is used to help equipment meet various regulatory requirements including: GR 1089, ITU K.20, K.21 & K.45, IEC 60950, UL 60950 and FCC Part 68.

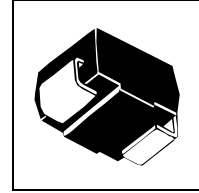

Part Number*	V _{DRM} Volts	V _S Volts	V _T Volts	I _{DRM} μAmps	I _S mAmps	I _T Amps	I _H mAmps	C _O pF
P0080S_	6	25	5	5	800	1	50	100
P0300S_	25	40	5	5	800	1	50	110
P0640S_	58	77	5	5	800	1	150	50
P0720S_	65	88	5	5	800	1	150	50
P0900S_	75	98	5	5	800	1	150	50
P1100S_	90	130	5	5	800	1	150	40
P1300S_	120	160	5	5	800	1	150	40
P1500S_	140	180	5	5	800	1	150	40
P1800S_	170	220	5	5	800	1	150	30
P2300S_	190	260	5	5	800	1	150	30
P2600S_	220	300	5	5	800	1	150	30
P3100S_	275	350	5	5	800	1	150	30
P3500S_	320	400	5	5	800	1	150	30

* For individual "SA", "SB" and "SC" surge ratings, see table below. (P0080SB is not available)

Notes:

- All measurements are made at an ambient temperature of 25°C. I_{PP} applies to -40°C through +85°C temperature range.
- I_{PP} is a repetitive surge rating and is guaranteed for the life of the product.
- Listed SIDACtors devices are bi-directional. All electrical parameters & surge ratings apply to forward and reverse polarities.
- V_{DRM} is measured at I_{DRM}.
- V_S is measured at 100V/μs.
- Special voltage (V_S & V_{DRM}) and holding current (I_H) requirements are available upon request.
- Off-state capacitance is measured at 1MHz with a 2 volt bias and is a typical value for "SA" and "SB" product. "SC" capacitance is approximately 2x the listed value. The off-state capacitance of the P0080SB is equal to our "SC" device.

Surge Ratings

Series	I _{PP} 2x10μs Amps	I _{PP} 8x20μs Amps	I _{PP} 10x160μs Amps	I _{PP} 10x560μs Amps	I _{PP} 10x1000μs Amps	I _{TSM} 60Hz Amps	di/dt Amps/μs
A	200	150	100	60	50	20	500
B	250	250	150	100	80	30	500
C	500	400	200	150	100	50	500

Thermal Considerations

Package	Symbol	Parameter	Value	Unit
DO-214AA	T_j	Operating Junction Temperature Range	-40 to +150	°C
	T_s	Storage Temperature Range	-65 to +150	°C
	T_c	Maximum Case Temperature	+115	°C
	$R_{\theta jc}$	Thermal Resistance: junction to case	+23	°C/W
	$R_{\theta ja}$	Thermal Resistance: junction to ambient	+90	°C/W

V-I Characteristics

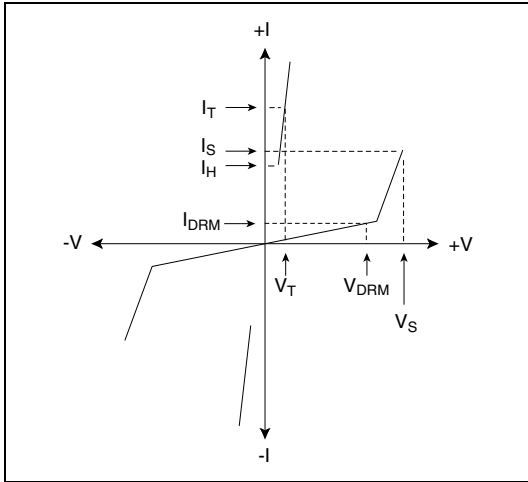

t_r, t_d Pulse Wave-form

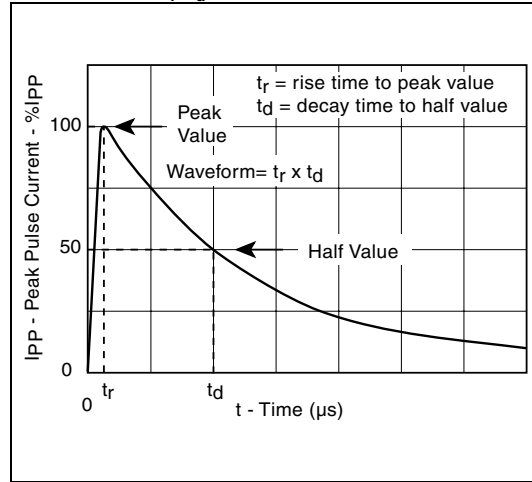

Normalized V_S Change vs. Junction Temperature

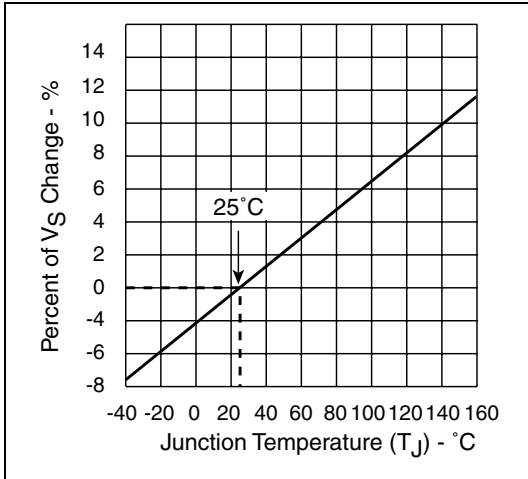

Normalized DC Holding Current vs. Case Temperature

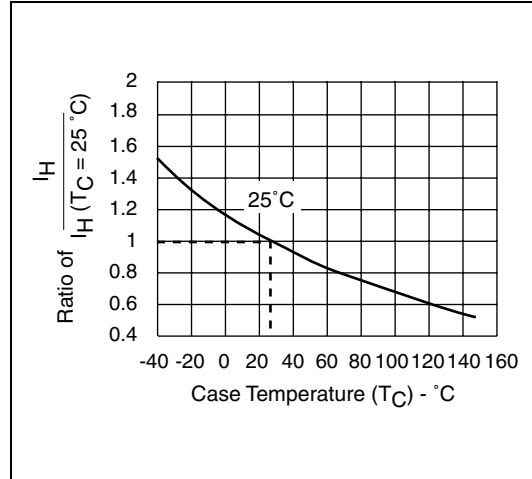

DO-214AA SIDACtor device

Package Symbolization

Standardized Part Number	Symbolized Part Number	Standardized Part Number	Symbolized Part Number
P0080SA	P-8A	P1300SC	P13C
P0080SB	P-8B	P1500SA	P15A
P0080SC	P-8C	P1500SB	P15B
P0300SA	P03A	P1500SC	P15C
P0300SB	P03B	P1800SA	P18A
P0300SC	P03C	P1800SB	P18B
P0640SA	P06A	P1800SC	P18C
P0640SB	P06B	P2000SA	P20A
P0640SC	P06C	P2000SB	P20B
P0641SA	P61A	P2000SC	P20C
P0641SC	P61C	P2300SA	P23A
P0720SA	P07A	P2300SB	P23B
P0720SB	P07B	P2300SC	P23C
P0720SC	P07C	P2600SA	P26A
P0721SA	P71A	P2600SB	P26B
P0721SC	P71C	P2600SC	P26C
P0900SA	P09A	P3100SA	P31A
P0900SB	P09B	P3100SB	P31B
P0900SC	P09C	P3100SC	P31C
P0901SA	P91A	P3500SA	P35A
P0901SC	P91C	P3500SB	P35B
P1100SA	P11A	P3500SC	P35C
P1100SB	P11B	B1100CA	B10A
P1100SC	P11C	B1100CC	B10C
P1101SA	P01A	B1160CA	B16A
P1101SC	P01C	B1160CC	B16C
P1200SA	P12A	B1200CA	B12A
P1200SB	P12B	B1200CC	B12C
P1200SC	P12C	B2050CA	B20A
P1300SA	P13A	B2050CC	B20C
P1300SB	P13B		

Data Sheets

Note: On the DO-214AA package, date code is located below the Symbolized Part Number. TO-92 and TO-220 devices have full part numbers and a date code printed on the part.

TO-92 SIDACtor device

The TO-92 SIDACtor solid state device designed is for telecommunication protection applications for modems, line cards, fax machines, etc.

The SIDACtor device is used to help equipment meet various regulatory requirements including: GR 1089, ITU K.20, K.21, & K.45, IEC 60950, UL 60950 and FCC Part 68.

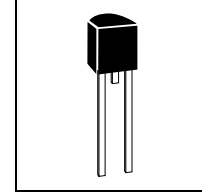

Electrical Parameters

Part Number*	V _{DRM} Volts	V _S Volts	V _T Volts	I _{DRM} μAmps	I _S mAmps	I _T Amps	I _H mAmps	C _O pF
P0080E_	6	25	5	5	800	1	50	100
P0300E_	25	40	5	5	800	1	50	110
P0640E_	58	77	5	5	800	1	150	50
P0720E_	65	88	5	5	800	1	150	50
P0900E_	75	98	5	5	800	1	150	50
P1100E_	90	130	5	5	800	1	150	40
P1300E_	120	160	5	5	800	1	150	40
P1500E_	140	180	5	5	800	1	150	40
P1800E_	170	220	5	5	800	1	150	30
P2300E_	190	260	5	5	800	1	150	30
P2600E_	220	300	5	5	800	1	150	30
P3100E_	275	350	5	5	800	1	150	30
P3500E_	320	400	5	5	800	1	150	30

* For individual "EA", "EB" and "EC" surge ratings, see table below. (P0080EB is not available.)

Notes:

- All measurements are made at an ambient temperature of 25°C. I_{PP} applies to -40°C through +85°C temperature range.
- I_{PP} is a repetitive surge rating and is guaranteed for the life of the product.
- Listed SIDACtors devices are bi-directional. All electrical parameters & surge ratings apply to forward and reverse polarities.
- V_{DRM} is measured at I_{DRM}.
- V_S is measured at 100V/μs.
- Special voltage (V_S & V_{DRM}) and holding current (I_H) requirements are available upon request.
- Off-state capacitance is measured at 1MHz with a 2 volt bias and is a typical value for "EA" and "EB" product. "EC" capacitance is approximately 2x the listed value.

Surge Ratings

Series	I _{PP} 2x10μs Amps	I _{PP} 8x20μs Amps	I _{PP} 10x160μs Amps	I _{PP} 10x560μs Amps	I _{PP} 10x1000μs Amps	I _{TSM} 60Hz Amps	di/dt Amps/μs
A	200	150	100	60	50	20	500
B	250	250	150	100	80	30	500
C	500	400	200	150	100	50	500

Thermal Considerations

Package	Symbol	Parameter	Value	Unit
TO-92	T_j	Operating Junction Temperature Range	-40 to +150	°C
	T_s	Storage Temperature Range	-65 to +150	°C
	T_c	Maximum Case Temperature	+110	°C
	$R_{\theta jc}$	Thermal Resistance: junction to case	+28	°C/W
	$R_{\theta ja}$	Thermal Resistance: junction to ambient	+90	°C/W

Data Sheets

V-I Characteristics

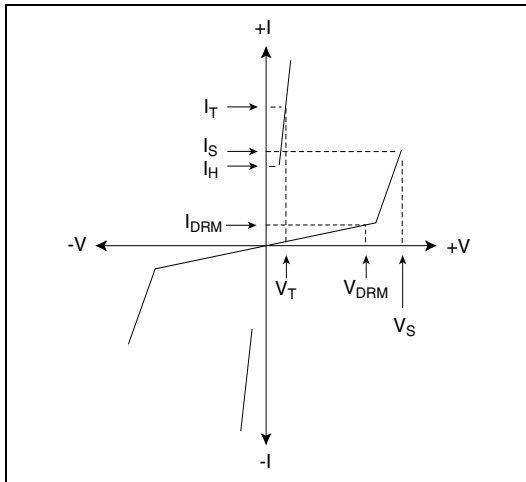

t_r, t_d Pulse Wave-form

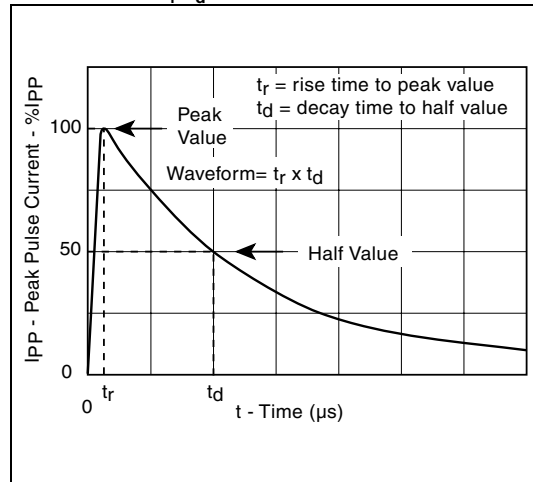

Normalized V_S Change vs. Junction Temperature

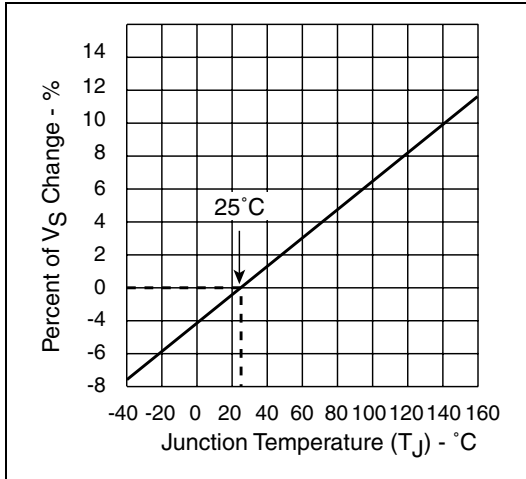

Normalized DC Holding Current vs. Case Temperature

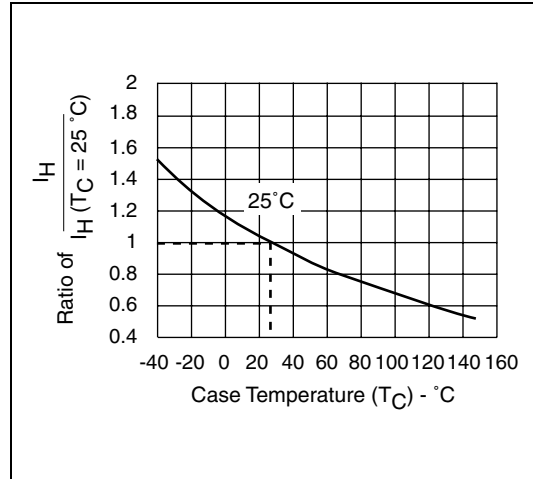

TO-220 Type 61 SIDACtor device

The modified TO-220 Type 61 SIDACtor solid state protection device is designed for telecommunication protection applications that do not reference earth ground.

The SIDACtor device is used to help equipment meet various regulatory requirements including: GR 1089, ITU K.20, K.21 & K.45, IEC 60950, UL 60950 and FCC Part 68.

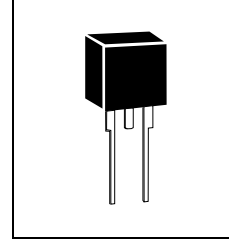

Electrical Parameters

Part Number	V _{DRM} Volts	V _S Volts	V _T Volts	I _{DRM} μAmps	I _S mAmps	I _T Amps	I _H mAmps	C _O pF
P2000AA61	180	220	5	5	800	1	150	30
P2200AA61	200	240	5	5	800	1	150	30
P2400AA61	220	260	5	5	800	1	150	30
P2500AA61	240	290	5	5	800	1	150	30
P3000AA61	270	330	5	5	800	1	150	30
P3300AA61	300	360	5	5	800	1	150	30

Notes:

- All measurements are made at an ambient temperature of 25°C. I_{PP} applies to -40°C through +85°C temperature range.
- I_{PP} is a repetitive surge rating and is guaranteed for the life of the product.
- Listed SIDACtor device are bi-directional. All electrical parameters & surge ratings apply to forward and reverse polarities.
- V_{DRM} is measured at I_{DRM}.
- V_S is measured at 100V/μs.
- Special voltage (V_S & V_{DRM}) and holding current (I_H) requirements are available upon request.
- Off-state capacitance is measured at 1MHz with a 2 volt bias and is a typical value.

Surge Ratings

Series	I _{PP} 0.2x310μs Amps	I _{PP} 2x10μs Amps	I _{PP} 8x20μs Amps	I _{PP} 10x160μs Amps	I _{PP} 10x560μs Amps	I _{PP} 5x320μs Amps	I _{PP} 10x1000μs Amps	I _{TSM} 60Hz Amps	di/dt Amps/μs
A	20	200	150	100	60	75	50	20	500

Thermal Considerations

Package	Symbol	Parameter	Value	Unit
Modified TO-220	T_j	Operating Junction Temperature Range	-40 to +150	°C
	T_s	Storage Temperature Range	-65 to +150	°C
	T_c	Maximum Case Temperature	+115	°C
	$R_{\theta jc}$	Thermal Resistance: junction to case	+12	°C/W
	$R_{\theta ja}$	Thermal Resistance: junction to ambient	+50	°C/W

Data Sheets

V-I Characteristics

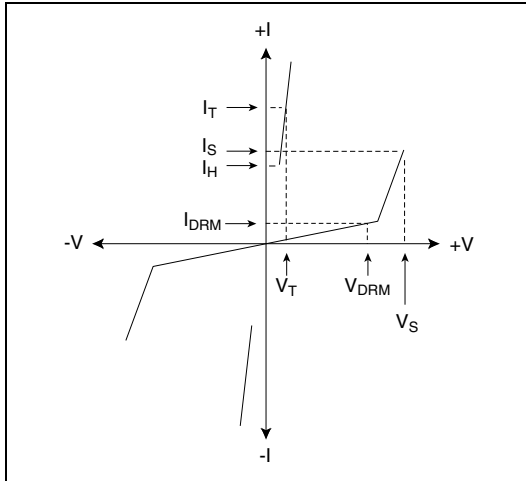

t_r, t_d Pulse Wave-form

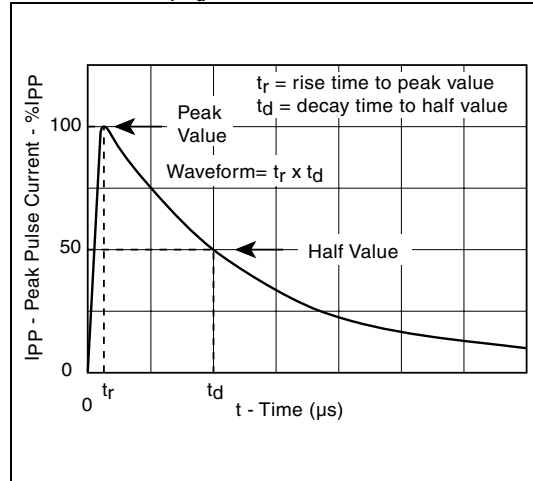

Normalized V_S Change vs. Junction Temperature

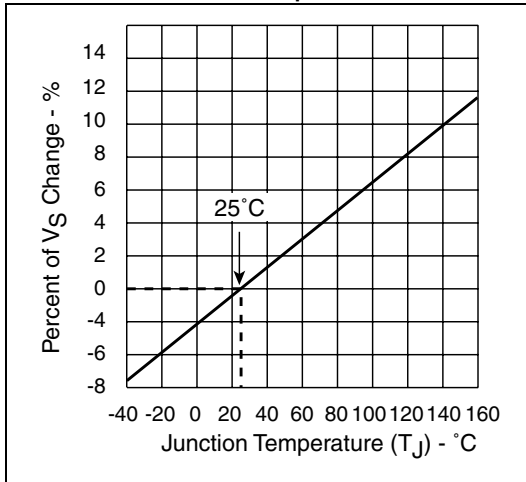

Normalized DC Holding Current vs. Case Temperature

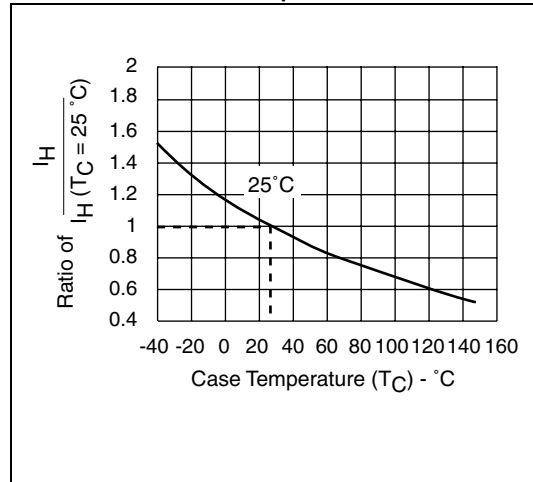

Two Chip TO-220 SIDACtor device

The two chip modified TO-220 SIDACtor solid state device is designed for telecommunication protection applications that reference Tip and Ring to earth ground but do not require balanced protection.

The SIDACtor device is used to help meet various regulatory requirements including: GR 1089, ITU K.20, K.21 & K.45, IEC 60950, UL 60950 and FCC Part 68.

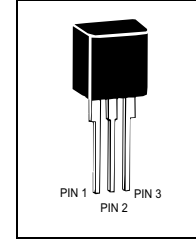

Electrical Parameters

Part Number*	V _{DRM} Volts pins 1-2, 3-2	V _S Volts	V _{DRM} Volts pins 1-3	V _S Volts	V _T Volts	I _{DRM} μAmps	I _S mAmps	I _T Amps	I _H mAmps	C _O pF
P0602A_	25	40	50	80	5	5	800	1	50	110
P1402A_	58	77	116	154	5	5	800	1	150	50
P1602A_	65	95	130	190	5	5	800	1	150	50
P2202A_	90	130	180	260	5	5	800	1	150	40
P2702A_	120	160	240	320	5	5	800	1	150	40
P3002A_	140	180	280	360	5	5	800	1	150	40
P3602A_	170	220	320	440	5	5	800	1	150	40
P4202A_	190	250	380	500	5	5	800	1	150	30
P4802A_	220	300	440	600	5	5	800	1	150	30
P6002A_	275	350	550	700	5	5	800	1	150	30

* For individual "AA", "AB" and "AC" surge ratings, see table below.

Notes:

- All measurements are made at an ambient temperature of 25°C. I_{PP} applies to -40°C through +85°C temperature range.
- I_{PP} is a repetitive surge rating and is guaranteed for the life of the product.
- Listed SIDACtor devices are bi-directional. All electrical parameters & surge ratings apply to forward and reverse polarities.
- V_{DRM} is measured at I_{DRM}.
- V_S is measured at 100V/μs.
- Special voltage (V_S & V_{DRM}) and holding current (I_H) requirements are available upon request.
- Off-state capacitance is measured between PINS 1-2 and 3-2 at 1MHz with a 2 volt bias and is a typical value for "AA" and "AB" product. "AC" capacitance is approximately 2x the listed value.

Surge Ratings

Series	I _{PP} 2x10μs Amps	I _{PP} 8x20μs Amps	I _{PP} 10x160μs Amps	I _{PP} 10x560μs Amps	I _{PP} 10x1000μs Amps	I _{TSM} 60Hz Amps	dI/dt Amps/μs
A	200	150	100	60	50	20	500
B	250	250	150	100	80	30	500
C	500	400	200	150	100	50	500

Thermal Considerations

Package	Symbol	Parameter	Value	Unit
Modified TO-220	T_j	Operating Junction Temperature Range	-40 to +150	°C
	T_s	Storage Temperature Range	-65 to +150	°C
	T_c	Maximum Case Temperature	+115	°C
	$R_{\theta jc}$	Thermal Resistance: junction to case	+12	°C/W
	$R_{\theta ja}$	Thermal Resistance: junction to ambient	+50	°C/W

Data Sheets

V-I Characteristics

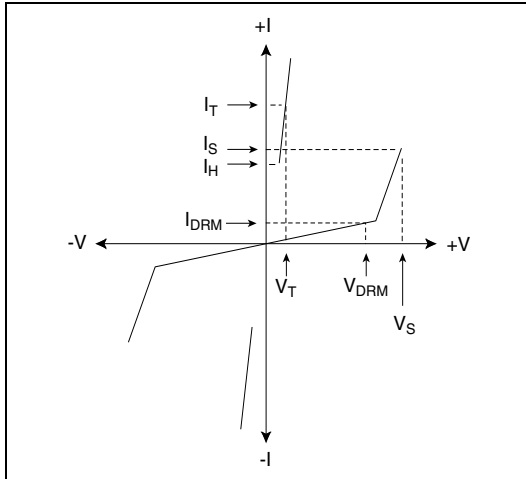

t_r, t_d Pulse Wave-form

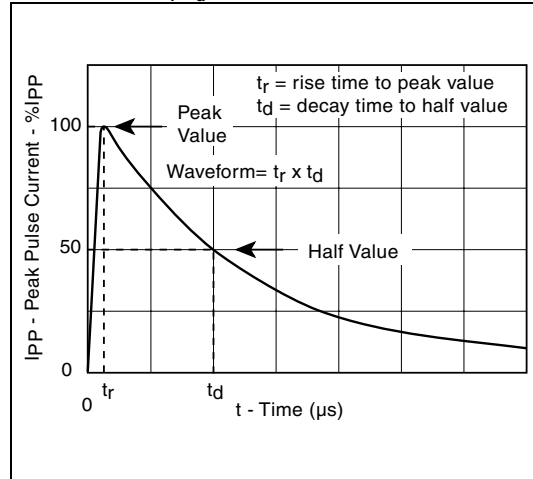

Normalized V_S Change vs. Junction Temperature

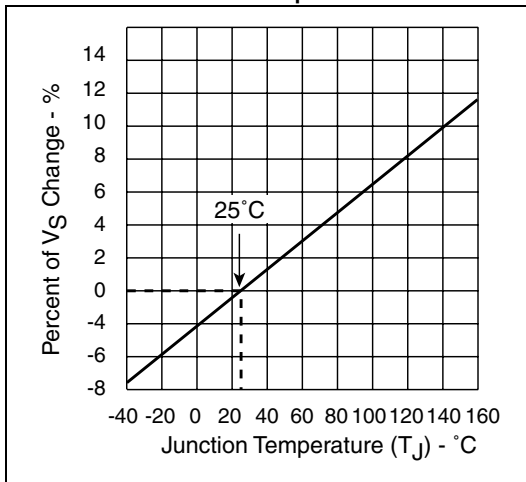

Normalized DC Holding Current vs. Case Temperature

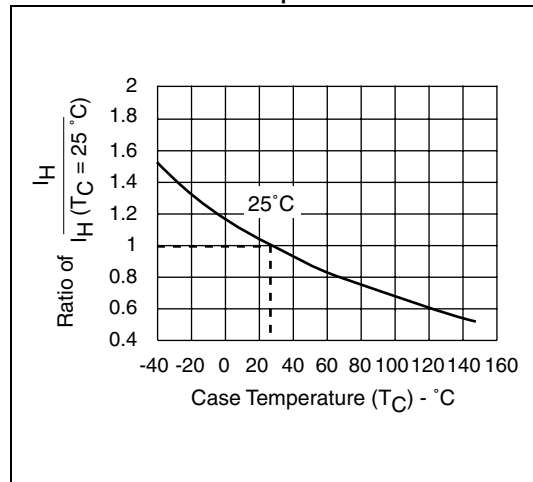

Balanced Three Chip TO-220 SIDACtor device

The three chip modified TO-220 SIDACtor balanced solid state device is designed for telecommunication protection systems that reference between Tip/ Ring to earth ground. Applications include any piece of transmission equipment that requires balanced protection.

The SIDACtor device is used to help equipment meet various regulatory requirements including: GR 1089, ITU K.20, K.21 & K.45, IEC 60950, UL 60950 and FCC Part 68.

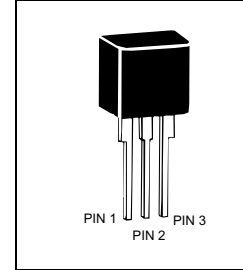

Electrical Parameters

Part Number*	V _{DRM} Volts pins 1-2, 3-2	V _S Volts pins 1-2, 3-2	V _{DRM} Volts pins 1-3	V _S Volts pins 1-3	V _T Volts	I _{DRM} µAmps	I _S mAmps	I _T Amps	I _H mAmps	C _O pF
P1553A_	130	180	130	180	10	5	800	1	150	40
P1803A_	150	210	150	210	10	5	800	1	150	40
P2103A_	170	250	170	250	10	5	800	1	150	40
P2353A_	200	270	200	270	10	5	800	1	150	40
P2703A_	230	300	230	300	10	5	800	1	150	30
P3203A_	270	350	270	350	10	5	800	1	150	30
P3403A_	300	400	300	400	10	5	800	1	150	30
P5103A_	420	600	420	600	10	5	800	1	150	30

* For individual "AA", "AB" and "AC" surge ratings, see table below.

Notes:

- All measurements are made at an ambient temperature of 25°C. I_{PP} applies to -40°C through +85°C temperature range.
- I_{PP} is a repetitive surge rating and is guaranteed for the life of the product.
- Listed SIDACtor devices are bi-directional. All electrical parameters & surge ratings apply to forward and reverse polarities.
- V_{DRM} is measured at I_{DRM}.
- V_S is measured at 100V/µs.
- Special voltage (V_S & V_{DRM}) and holding current (I_H) requirements are available upon request.
- Off-state capacitance is measured between (Pin 1-2 and 3-2) at 1MHz with a 2 volt bias and is a typical value for "AA". "AB" and "AC" capacitance is approximately 2x the listed value.
- Designed to meet balance requirements of GTS 8700 and GR 974.

Surge Ratings

Series	I _{PP} 2x10µs Amps	I _{PP} 8x20µs Amps	I _{PP} 10x160µs Amps	I _{PP} 10x560µs Amps	I _{PP} 10x1000µs Amps	I _{TSM} 60Hz Amps	di/dt Amps/µs
A	200	150	100	60	50	20	500
B	250	250	150	100	80	30	500
C	500	400	200	150	100	50	500

Thermal Considerations

Package	Symbol	Parameter	Value	Unit
Modified TO-220	T_j	Operating Junction Temperature Range	-40 to +150	°C
	T_s	Storage Temperature Range	-65 to +150	°C
	T_c	Maximum Case Temperature	+115	°C
	$R_{\theta jc}$	Thermal Resistance: junction to case	+12	°C/W
	$R_{\theta ja}$	Thermal Resistance: junction to ambient	+50	°C/W

Data Sheets

V-I Characteristics

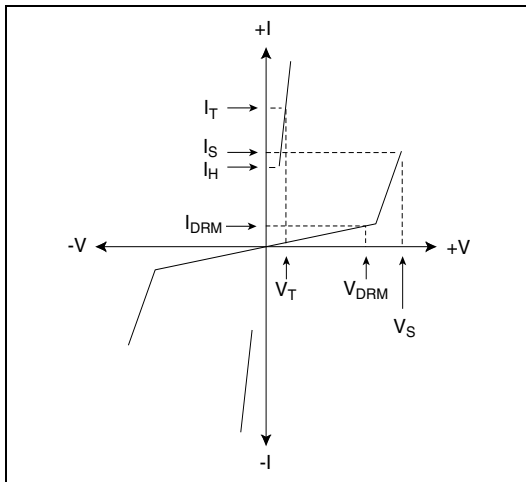

t_r, t_d Pulse Wave-form

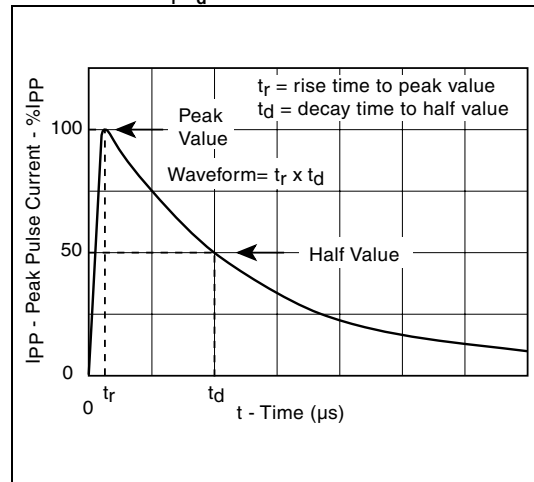

Normalized V_S Change vs. Junction Temperature

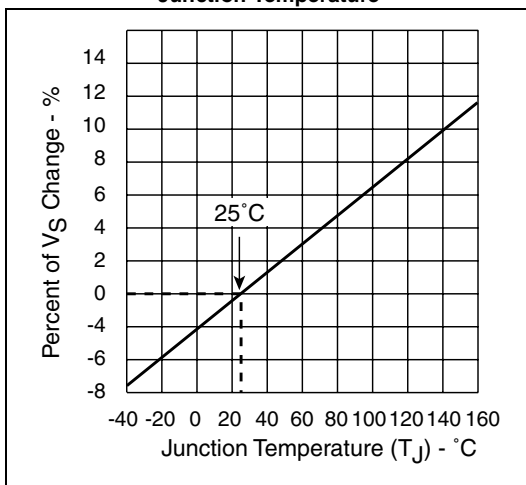

Normalized DC Holding Current vs. Case Temperature

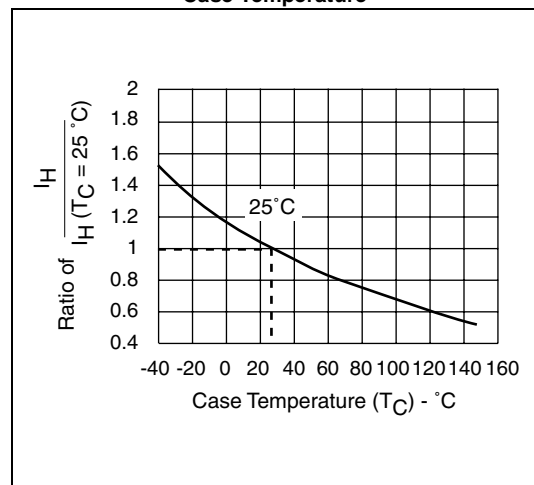

Subscriber Line Interface Circuit (SLIC) Protection (DO-214AA)

The P0641S_, P0721S_, P0901S_, and the P1101S_ are unidirectional solid state protection devices constructed with a SIDACTor device and an integrated diode.

Used to protect SLIC IC's from being damaged during transient voltage activity, the P0641S_, P0721S_, P0901S_, and P1101S_ help line cards meet various regulatory requirements including: GR 1089, ITU K.20, K.21 & K.45, IEC 60950, UL 60950 and FCC Part 68.

For specific design criteria see page 3-21.

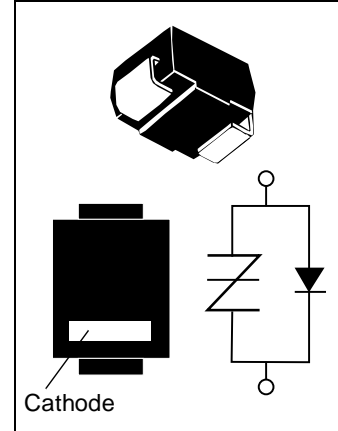

Electrical Parameters

Part Number*	V _{DRM} Volts	V _S Volts	V _T Volts	V _F Volts	I _{DRM} μAmps	I _S mAmps	I _T Amps	I _H mAmps	C _{OPF}
P0641S_	58	77	5	5	5	800	1	120	70
P0721S_	65	88	5	5	5	800	1	120	70
P0901S_	75	98	5	5	5	800	1	120	70
P1101S_	95	130	5	5	5	800	1	120	70

* For individual "SA", "SB" and "SC" surge ratings, see table below.

Notes:

- All measurements are made at an ambient temperature of 25°C. I_{PP} applies to -40°C through +85°C temperature range.
- I_{PP} is a repetitive surge rating and is guaranteed for the life of the product.
- V_{DRM} is measured at I_{DRM}.
- V_S and V_F are measured at 100V/μs.
- Special voltage (V_S & V_{DRM}) and holding current (I_H) requirements are available upon request.
- Off-state capacitance is measured at 1MHz with a 2 volt bias and is a typical value for "SA" product. "SC" capacitance is approximately 2x the listed value.
- Parallel capacitive loads may affect electrical parameters.

Surge Ratings (Preliminary Data)

Series	I _{PP} 2x10μs Amps	I _{PP} 8x20μs Amps	I _{PP} 10x160μs Amps	I _{PP} 10x560μs Amps	I _{PP} 10x1000μs Amps	I _{TSM} 60Hz Amps	di/dt Amps/μs
A	200	150	100	60	50	20	500
B	300	250	150	100	80	30	500
C	500	400	200	120	100	50	500

Thermal Considerations

Package	Symbol	Parameter	Value	Unit
DO-214AA	T_j	Operating Junction Temperature Range	-40 to +150	°C
	T_s	Storage Temperature Range	-65 to +150	°C
	T_c	Maximum Case Temperature	+115	°C
	$R_{\theta jc}$	Thermal Resistance: junction to case	+23	°C/W
	$R_{\theta ja}$	Thermal Resistance: junction to ambient	+90	°C/W

Data Sheets

V-I Characteristics

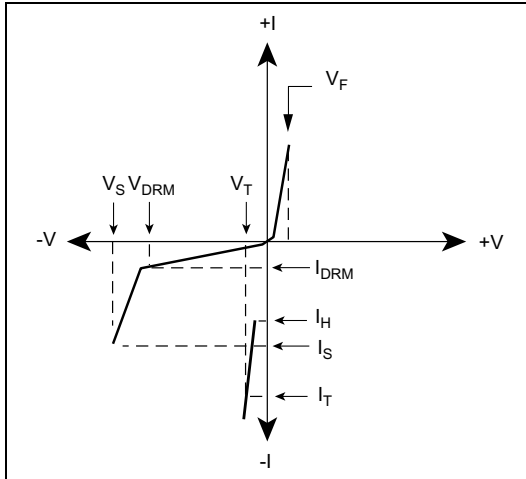

t_r, t_d Pulse Wave-form

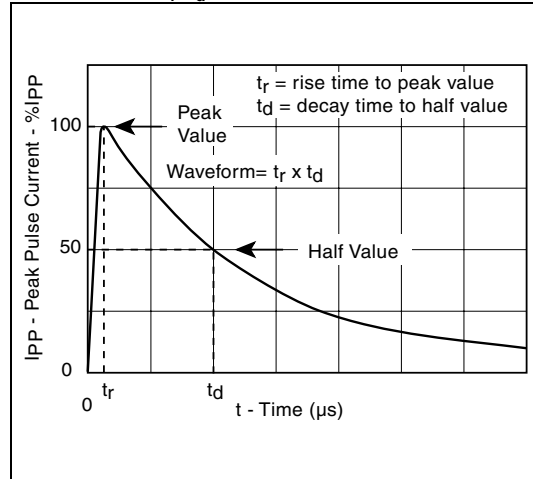

Normalized V_S Change vs. Junction Temperature

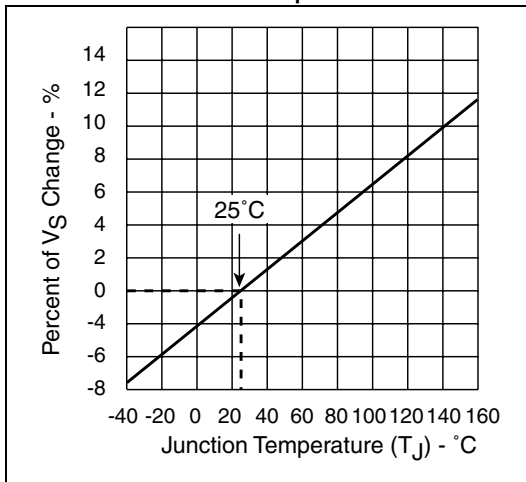

Normalized DC Holding Current vs. Case Temperature

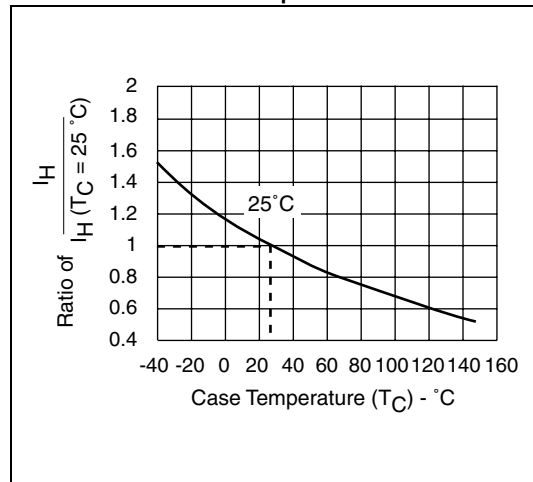

Subscriber Line Interface Circuit (SLIC) Protection Battrax (Modified DO-214AA)

The Battrax is a solid state protection device that can be referenced to either a positive or negative voltage source. The B1xx0C_ is for a $-V_{REF}$ and the B2050C_ is for a $+V_{REF}$. Designed using an SCR and an integrated diode, the B1xx0C_ Battrax begins to conduct at $|-V_{REF}|+|-1.2V|$ while the B2050C_ Battrax begins to conduct at $+V_{REF}|+|1.2V|$.

For specific diagrams using the Battrax, please see pages 3-21 and 3-22.

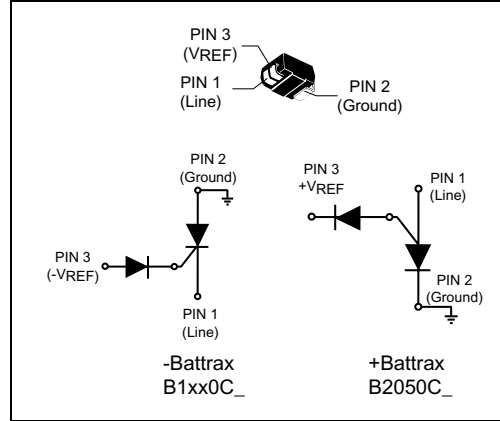

Electrical Parameters (Preliminary Data for Positive Tracking Devices)

Part Number*	V_{DRM} Volts	V_S Volts	V_T Volts	V_F Volts	I_{DRM} μ Amps	I_{GT} mAmps	I_T Amps	I_H mAmps	C_O pF
B1100C_	$ -V_{REF} + -1.2V $	$ -V_{REF} + -10V $	5	5	5	100	1	100	50
B1160C_	$ -V_{REF} + -1.2V $	$ -V_{REF} + -10V $	5	5	5	100	1	160	50
B1200C_	$ -V_{REF} + -1.2V $	$ -V_{REF} + -10V $	5	5	5	100	1	200	50
B2050C_	$+V_{REF} + 1.2V $	$+V_{REF} + 10V$	5	5	5	50	1	50	50

* For individual "CA" and "CC" surge ratings, see table below.

Notes:

- All measurements are made at an ambient temperature of 25°C. I_{PP} applies to -40°C through +85°C temperature range.
- I_{PP} is a repetitive surge rating and is guaranteed for the life of the product.
- I_{PP} ratings assume a $V_{REF} = \pm 48V$.
- V_{DRM} is measured at I_{DRM} .
- V_S is measured at 100V/ μ s.
- Off-state capacitance is measured at 1MHz with a 2 volt bias and is a typical value. "CC" product is approximately 2x the listed value.
- +Battrax information is preliminary data.
- V_{REF} maximum value for the B1100, B1160, and/or B1200 is 200V.
- V_{REF} maximum value for the B2050 is 100V.

Surge Ratings (Preliminary Data for Positive Tracking Devices)

Series	I_{PP} 2x10 μ s Amps	I_{PP} 8x20 μ s Amps	I_{PP} 10x160 μ s Amps	I_{PP} 10x560 μ s Amps	I_{PP} 10x1000 μ s Amps	I_{TSM} 60Hz Amps	di/dt Amps/ μ s
A	200	150	100	60	50	40	500
C	500	400	200	150	100	50	500

Thermal Considerations

Package	Symbol	Parameter	Value	Unit
Batrax	T_j	Operating Junction Temperature Range	-40 to +150	°C
	T_s	Storage Temperature Range	-65 to +150	°C
	T_c	Maximum Case Temperature	+115	°C
	$R_{\theta jc}$	Thermal Resistance: junction to case	+23	°C/W
	$R_{\theta ja}$	Thermal Resistance: junction to ambient	+85	°C/W

Data Sheets

V-I Characteristics

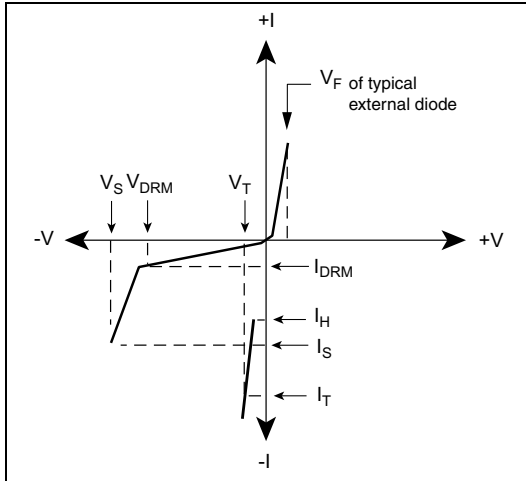

t_r, t_d Pulse Wave-form

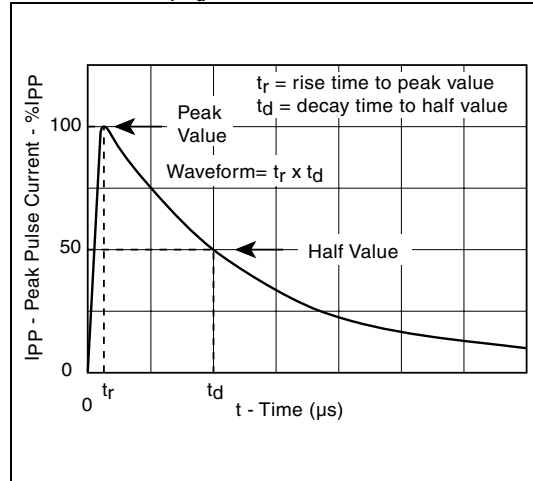

Normalized V_S Change vs. Junction Temperature

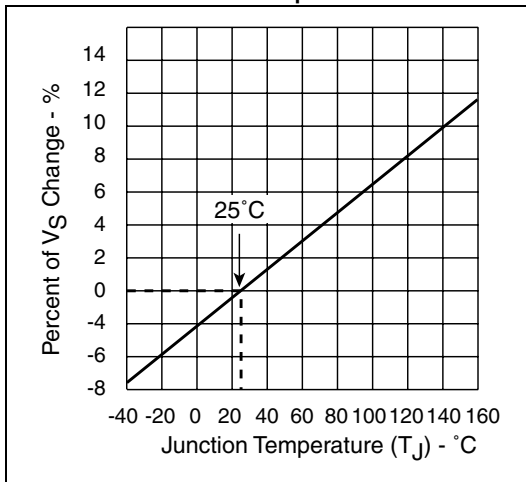

Normalized DC Holding Current vs. Case Temperature

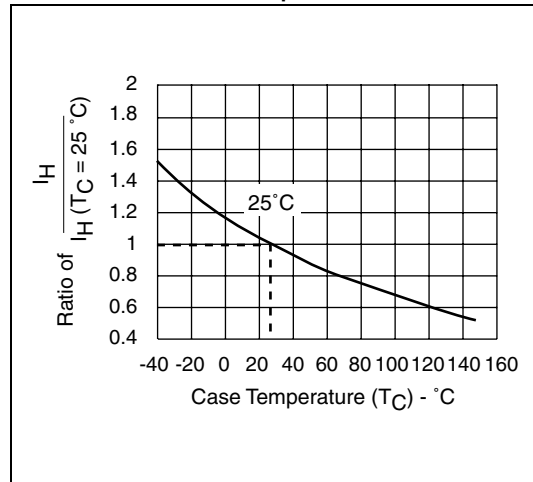

CATV Series SIDACtor device

The P1400AD SIDACtor device is a 1000A rated solid state protection device offered in a TO-220 package and is designed to meet the severe surge requirements found in a CATV environment.

Used in Hybrid Fiber Coax (HFC) applications, the P1400AD replaces the gas tube that is traditionally used for station protection due to the P1400AD's tight voltage tolerances.

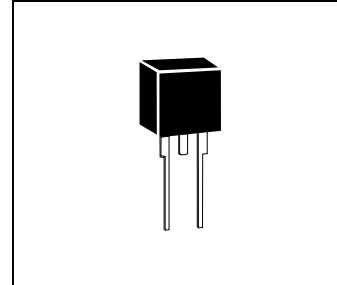

Electrical Parameters

Part Number	V _{DRM} Volts	V _S Volts	V _T Volts	I _{DRM} μAmps	I _S mAmps	I _T Amps	I _H mAmps	C _O pF
P1400AD	120	160	5	5	800	1	50	200

Notes:

- All measurements are made at an ambient temperature of 25°C. I_{PP} applies to -40°C through +85°C temperature range.
- I_{PP} is a repetitive surge rating and is guaranteed for the life of the product.
- Listed SIDACtor devices are bi-directional. All electrical parameters & surge ratings apply to forward and reverse polarities.
- V_{DRM} is measured at I_{DRM}.
- V_S is measured at 100V/μs.
- Special voltage (V_S & V_{DRM}) and holding current (I_H) requirements are available upon request.
- Off-state capacitance is measured at 1MHz with a 2 volt bias and is a typical value.

Surge Ratings

Series	I _{PP} 8x20μs Amps	I _{PP} 10x1000μs Amps	I _{TSM} 60Hz Amps	di/dt Amps/μs
P1400AD	1000	250	120	500

Thermal Considerations

Package	Symbol	Parameter	Value	Unit
P1400AD	T_J	Operating Junction Temperature Range	-40 to +150	°C
	T_S	Storage Temperature Range	-65 to +150	°C
	T_C	Maximum Case Temperature	80	°C
	$R_{\theta jc}$	Thermal Resistance: junction to case	2.8	°C/W
	$R_{\theta ja}$	Thermal Resistance: junction to ambient	60	°C/W

Data Sheets

V-I Characteristics

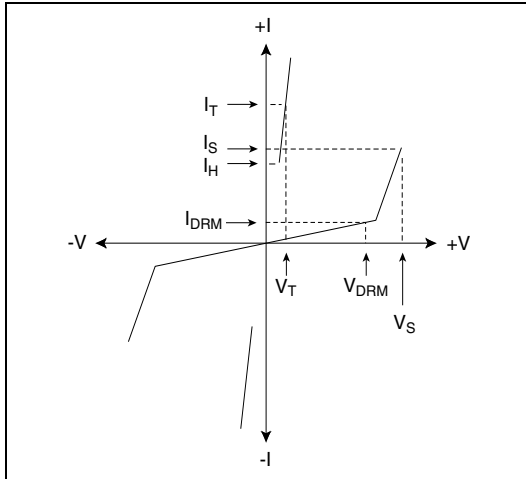

t_r, t_d Pulse Wave-form

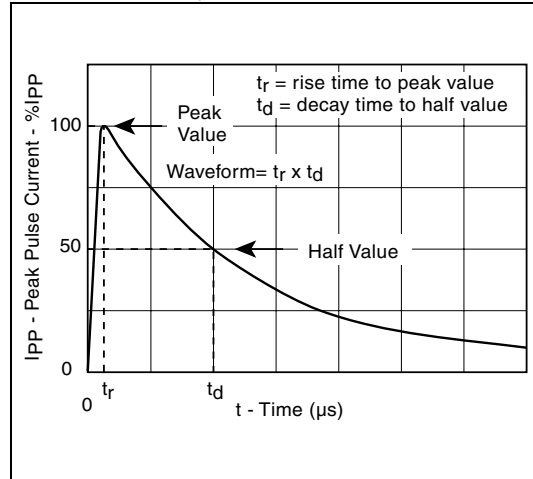

Normalized V_S Change vs. Junction Temperature

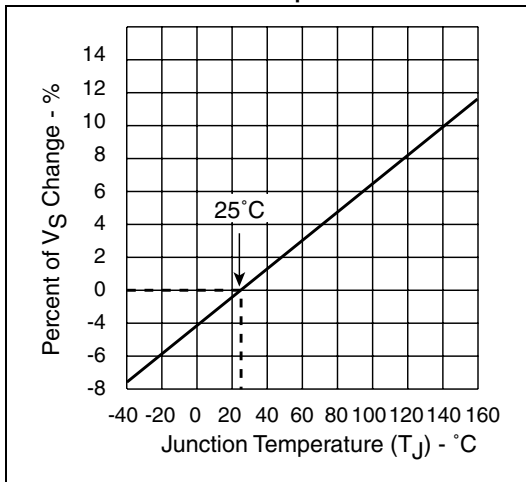

Normalized DC Holding Current vs. Case Temperature

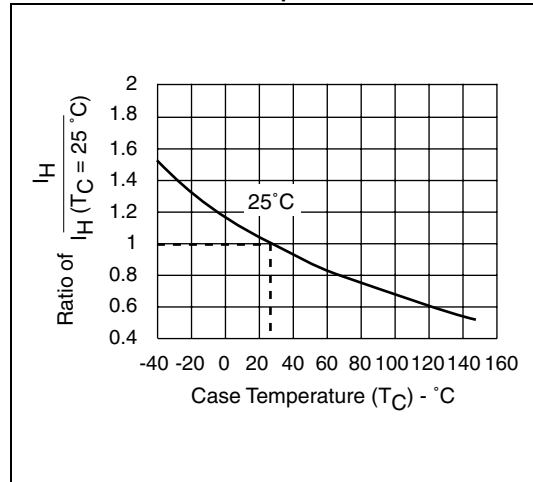

CATV Series SIDACtor device

The P1900ME SIDACtor device is a 3000A rated solid state protection device offered in a non-isolated TO-218 package and is designed to meet the severe surge requirements found in a CATV environment.

Used on CATV line amplifiers and power inserters, the P1900ME replaces traditional gas tubes due to the P1900ME's tight voltage tolerances.

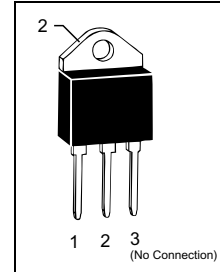

Electrical Parameters

Part Number	V _{DRM} Volts	V _S Volts	V _T Volts	I _{DRM} µAmps	I _S mAmps	I _T Amps*	I _H mAmps	C _O pF
P1900ME	140	220	5	5	800	2	50	750
P2300ME	180	260	5	5	800	2	50	750

* I_T is a free air rating; heat sink I_T rating is 25A.

Notes:

- All measurements are made at an ambient temperature of 25°C. I_{PP} applies to -40°C through +85°C temperature range.
- I_{PP} is a repetitive surge rating and is guaranteed for the life of the product.
- Listed SIDACtor devices are bi-directional. All electrical parameters & surge ratings apply to forward and reverse polarities.
- V_{DRM} is measured at I_{DRM}.
- V_S is measured at 100V/µs.
- Special voltage (V_S & V_{DRM}) and holding current (I_H) requirements are available upon request.
- Off-state capacitance is measured at 1MHz with a 2 volt bias and is a typical value.

Surge Ratings

Series	I _{PP} 8x20µs	I _{TSM} 60Hz	di/dt Amps/µs
P1900ME	3000	400	500
P2300ME	3000	400	500

Power Dissipation (Typical) vs On-State Current

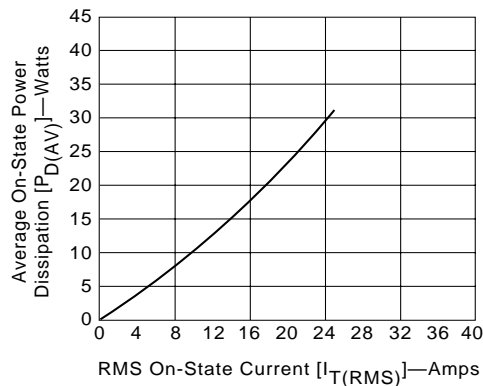

Thermal Considerations

Package	Symbol	Parameter	Value	Unit
P1900ME	T_J	Operating Junction Temperature Range	-40 to +150	°C
	T_S	Storage Temperature Range	-65 to +150	°C
	T_C	Maximum Case Temperature	+80	°C
	$R_{\theta jc}^*$	Thermal Resistance: junction to case	+2.8	°C/W
	$R_{\theta ja}$	Thermal Resistance: junction to ambient	+60	°C/W

* $R_{\theta jc}$ rating assumes heat sinking is employed.

Data Sheets

V-I Characteristics

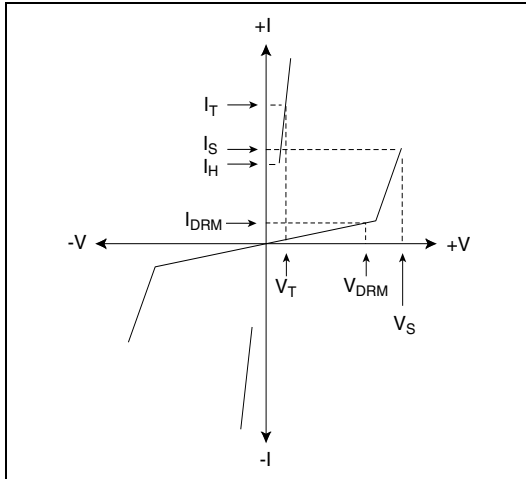

t_r, t_d Pulse Wave-form

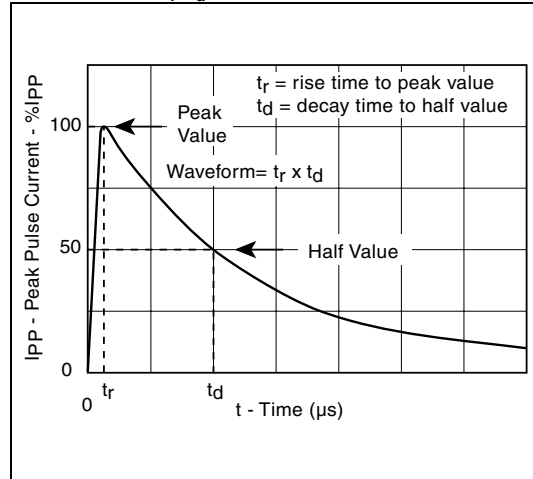

Normalized V_S Change vs. Junction Temperature

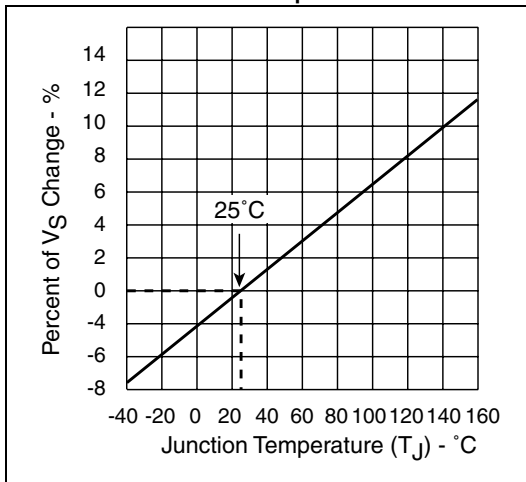

Normalized DC Holding Current vs. Case Temperature

